

PERGO®

VINYL PLANKS & TILES
COLLECTION 2023-2024



FLOORS FOR REAL LIFE

At Pergo we build strikingly beautiful, extremely hard-wearing floors. No shortcuts, no compromises, just the best in Scandinavian function, design and engineering. We invented laminate flooring and in fact, we've been innovating floors that have gone from strength to strength from the 1970's. Floors that are easy to install and maintain. And with one of the widest ranges around in wood, vinyl and laminate, you're sure to find the perfect one for you.

Come in and look around.



04

WHY PERGO VINYL FLOORS

The combination of Scandinavian minimalism with maximal choice. Vinyl floors are soft, silent, water resistant, durable - and look just like the real thing. Just quieter.

10

DURABLE. NATURALLY.

We constantly innovate to minimize the potential impact on our planet and to insure a healthy indoor environment.

12

RIGID CLICK

Soft, silent and hard-wearing flooring specially designed for installing on uneven surfaces and water resistant with AquaSafe.

40

ACCESSORIES

It is the little things that make big things happen. Complete the look with Pergo accessories of your choice.



WHY PERGO VINYL FLOORS?

Our Rigid vinyl floors are truly the combination of comfort, beauty and lifelong durability, born out of Scandinavian minimalism and deep sense of quality. Pergo vinyl floors offer maximal choice, from soft carpet designs to cool Terrazzo stone tiles and warm oaks.

Soft, silent and comfortable to walk on, yet ultra-strong, with excellent resistance to wear and scratches as well as a watertight surface. Pergo Rigid vinyl is very much the stunning embodiment of worry-free floors ready for anything. With a lifetime warranty, there is really nothing to worry about, only to enjoy.

Whether you're into DIY or use a professional company, installing your Pergo Rigid vinyl floor is super easy, thanks to the Uniclic® and the Unizip® click systems. Additionally, they come with the underlay integrated, which means there is no need for a separate one. Slightly uneven surfaces? Not a problem for our Rigid vinyl – making them a great match for renovations.

In simpler terms, if you're looking for floors that offer both comfort and durability, while also being beautiful and easy to install, your search ends here.



SOFT & SILENT

It feels warm, soft, and silent to walk on yet the floor is ultra-strong and has excellent resistance to wear and impact.



WATER RESISTANT

The floor has a worry-free watertight* surface and offers high resistance to stains, making it a delight to clean.



NATURAL LOOK & FEEL

Extraordinary natural designs and a tactile, matte surface. The floor will keep its fresh appearance thanks to our new superior top layer.



EASY TO INSTALL

Fast, easy installation with Uniclic® or Unizip® click system, even on slightly uneven surfaces.** All Pad Pro floors have an integrated underlay, which makes installation even faster and easier.



ACCESSORIES FOR A PERFECT RESULT

Everything you need from installation to the finished result and after care. Tools, colour matched skirtings and profiles, efficient maintenance products and more.



LIFETIME WARRANTY

All Pergo vinyl floors have lifetime warranty***, so that you can enjoy your floors without worry.

* Tested according to ISO 4760 (no leakage) and is not following EN13553 standards designed for welded resilient floor coverings.

** For requirements, please advise floor installation instructions on website: pergo.com.

*** For full warranty go to Pergo.com.



SOFT & SILENT

FLOORS FOR COMFORTABLE LIVING

A Pergo Rigid vinyl floor is a unique combination of comfort and durability. Defining our motto of Scandinavian functional design, the floors are warm to the touch and soft and silent to walk on – yet offers what can only be described as excellent resistance to wear and impact. Thanks to its acoustic layer in the core, the floor provides very pleasant room acoustics. Fantastic? Yes.



LYSEFJORD V4631-402319 BEIGE CABIN OAK



AQUASAFE

BECAUSE LIFE'S TOO SHORT
TO WORRY ABOUT WATER

All Pergo Rigid vinyl floors have AquaSafe, our in-house developed technology that creates a sealed, 100% watertight surface all the way down into the bevels, preventing water from penetrating the floor. It simply stands on the surface and you can easily wipe it away.



NATURAL LOOK & FEEL

ELEVATE ANY ROOM WITH LONG LASTING-BEAUTY

A Pergo Rigid vinyl floor has extraordinary natural designs and a tactile, matte surface, which make it look and feel just like oak, carpet or concrete - with all the worry-free benefits of a vinyl floor. Thanks to our superior protective top layer it will maintain its fresh appearance for you to show off to neighbours for years to come.



NEW IMPROVED SUPERIOR PROTECTIVE TOP LAYER

The ultra-durable top layer is nothing short of outstanding. Thanks to the in-house developed technique TitanV™ the floor has excellent resistance against wear and scratches. It ensures long-lasting beauty for your new floors and is a great fit for high traffic areas like hallways, or the kids' rooms, where risk of scuff marks is high. As if that wouldn't be great enough, the top layer also offers high resistance against spills and stains.

NEW PAD PRO THE FASTER, EASIER WAY TO INSTALL YOUR FLOOR

All of our Rigid click floors come with the underlay pre-attached, to make installing floors smarter, speedier and easier.

Specially designed for professional installers in multi housing projects, and enthusiasts who want to install more square metres in a day. Another advantage with the Pad Pro is that it gives great sound reduction to neighbouring rooms. Creating added comfort in your home.



QUICK AND EASY INSTALLATION

A really fast way to install your floor even if you're not a professional.

NO NEED FOR SEPARATE UNDERLAY

There is no need for sub-work, just go straight on with the floors.

SUPERIOR SOUND REDUCTION TO NEIGHBOURING ROOMS

Underlay is perfectly attached and gives optimal acoustics.

GREAT SUPPORT TO THE UNICLIC CLICKSYSTEM

OUR AMBITIOUS CLIMATE
TARGETS FOR 2030 ARE
VALIDATED BY THE SCIENCE
BASED TARGETS INITIATIVE.



Windmills at Unilin production plant.

DURABLE. NATURALLY.

We produce flooring as sustainable as possible, constantly innovating to minimize the potential impact on our planet. Therefore, we (Unilin Group) have linked ourselves to the Science Based Targets Initiative*. Our set and verified climate targets for 2030 put us firmly on the path to help limit global warming to 1.5°C, as outlined by the Paris Agreement.

GREEN ENERGY PRODUCTION

Unilin, the group behind Pergo, has invested in green energy for many years. Today we are operating at 60% renewable energy thanks to windmills, solar panels and even two co-owned biomass plants.

VINYL COMPONENTS

A Pergo vinyl floor consist of ±40% chalk, a material abundantly available in nature, ±25% internally recycled PVC generated from our own production waste, ±25% new PVC, made from chlorine (common salt) and ethylene (crude oil) and additives/plasticizers.

ORTHOPHTALATE-FREE

Additives in our vinyl flooring contain no harmful substances and are 100% orthophtalate-free. The only type of plasticizers we use are the same used in kid's toys and food storage purposes, which means they are completely safe.

We produce flooring in-house so we know exactly which materials they contain and we can control emissions of harmful substances. VOC emissions of our vinyl floors are lower than the European norm, resulting in an A+ rating and M1 label for very low emissions.

SWITCHING TO CIRCULAR PROCESSES

We want to reduce our carbon footprint, by limiting our use of new raw materials and switching to recycled materials.

INTERNAL ECOSYSTEM

More than 99% of our own industrial waste is recycled through our internal production process. We do not unnecessarily burn or dump materials and we operate our own internal closed circuit. This indicates that our production facility takes its responsibility seriously, ensuring that virtually no waste is lost or destroyed.

Did you know that we have the biggest LVT-recycling unit in Europe? We recycle more than 40.000 tons of LVT each year. We are also pioneering in post consumer recycling projects and investing in new production technologies to switch to post consumer recycled content in the core of our future vinyl floors.

DURABLE PRODUCTS

We do everything possible to ensure our vinyl flooring will last up to lifetime. That's why we are proud to offer lifetime warranty** on our vinyl floor.



* The Sciences Based Targets initiative (SBTi) is a collaboration between CDP, the United Nations Global Compact, World Resources Institute (WRI) and the Worldwide Fund for Nature (WWF). The SBTi defines and promotes best practice in science-based target setting, and independently assesses and validates companies' climate targets.

** For full warranty go to [Pergo.com](https://pergo.com).

VINYL PLANKS & TILES COLLECTION

Soft, silent and warm to live on, yet ultra-strong and with high resistance to water, wear and stains. Our Rigid vinyl floors will look just as good after years of hard wearing as they do when they're new. They are easy to install and you can even fit them on irregular floors*, so they're perfect for that renovation job.

**for requirements, please advise floor installation instructions on website: pergo.com*

Transform the feeling of your entire room.
Make it wider, narrower, longer, darker
or lighter depending on which size and colour
you choose – the options are endless.

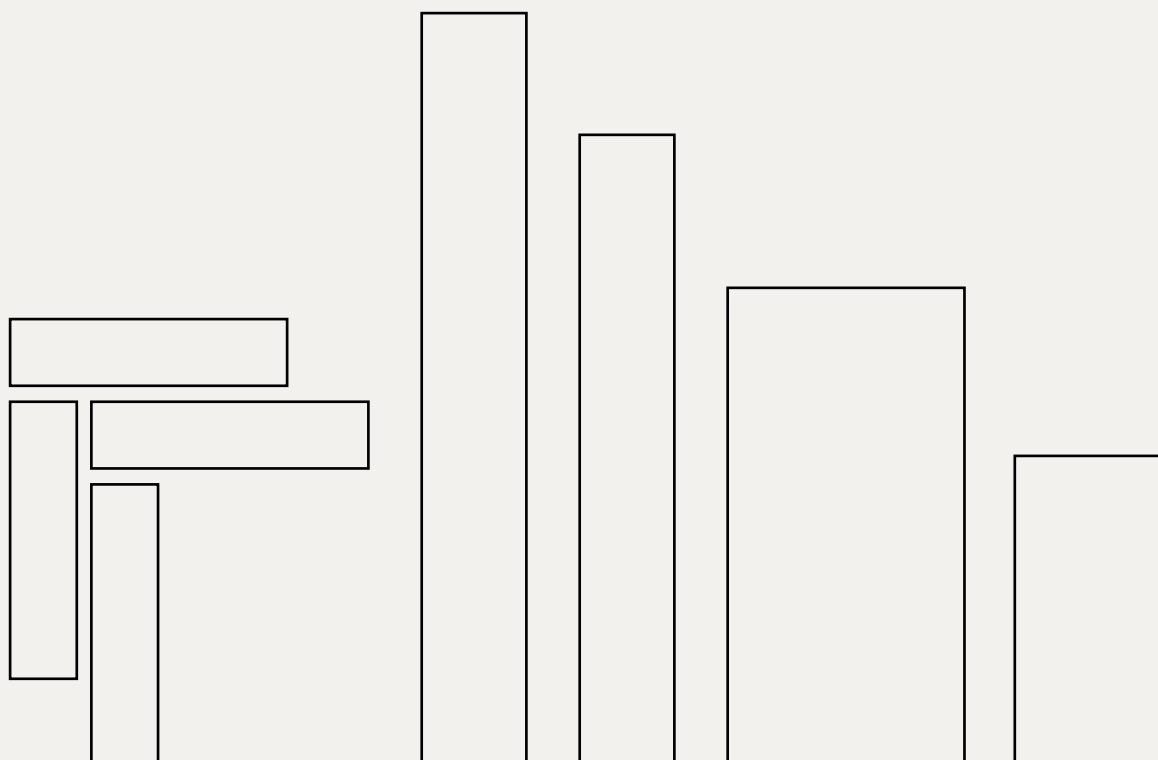

VOXNAN

LYSEFJORD

OTRA

LIMFJORD

AURA

VOXNAN	PAD PRO 630 × 126 × 5+1 mm
LYSEFJORD	PAD PRO 1494 × 209 × 5+1 mm
OTRA	PAD PRO 1251 × 189 × 4+1 mm PRO 1251 × 189 × 4 mm
LIMFJORD	PAD PRO 856 × 428 × 5+1 mm
AURA	PAD PRO 610 × 303 × 4+1 mm PRO 610 × 303 × 4 mm



14 NEW VOXNAN
Herringbone vinyl planks in a modern generous size.



28 LIMFJORD
Large vinyl tiles with elegant stone and stylish carpet designs.



20 LYSEFJORD
Medium sized vinyl planks, suitable for rooms of any size.

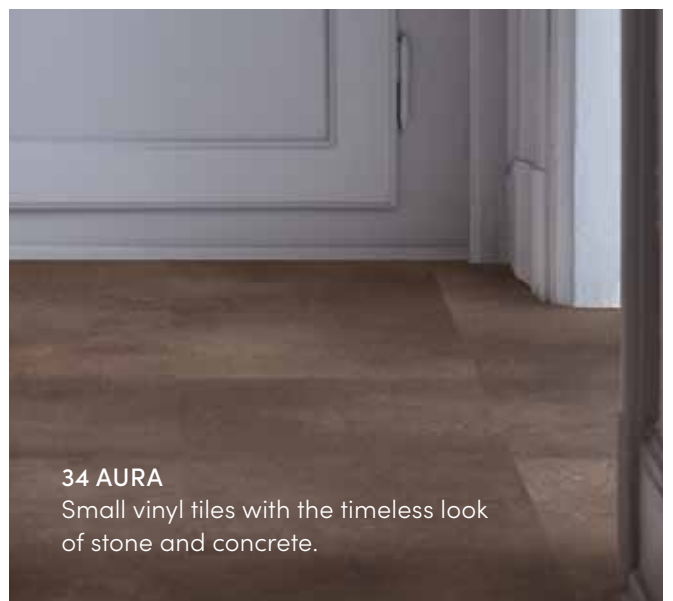

34 AURA
Small vinyl tiles with the timeless look of stone and concrete.



24 OTRA
Classic sized vinyl planks that grace any room.

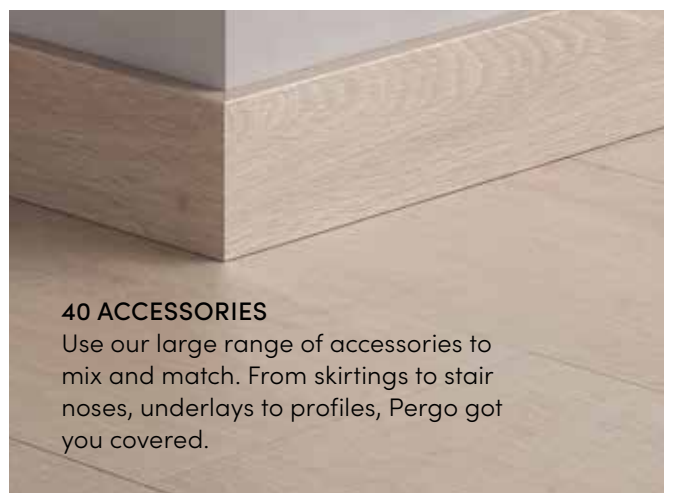

40 ACCESSORIES
Use our large range of accessories to mix and match. From skirtings to stair noses, underlays to profiles, Pergo got you covered.



VOXNAN V4624-40362 BEIGE VALLEY OAK



VOXNAN V4624-40361 LIGHT DANISH OAK

NEW VOXNAN - THE SOFT AND SILENT HERRINGBONE DREAM

Reminiscent of fine manor houses and heritage buildings, our new Voxnan herringbone rigid vinyl floors bring elegance and sense of luxury to any room. With a generous, contemporary plank size and available in a variety of different decors, you will be able to create a statement in any room of your home.

And thanks to the AquaSafe technique, Vorma is a great choice even in rooms where the risk of spills is high.



VOXNAN V4624-40359 NATURAL DANISH OAK





VOXNAN V4624-40364 CARAMEL VALLEY OAK



LIGHT DANISH OAK
PAD PRO V4624-40361



NATURAL DANISH OAK
PAD PRO V4624-40359



BEIGE VALLEY OAK
PAD PRO V4624-40362



HONEY DANISH OAK
PAD PRO V4624-40360



SMOKED VALLEY OAK
PAD PRO V4624-40363



CARAMEL VALLEY OAK
PAD PRO V4624-40364



COLOUR MATCHING ACCESSORIES
SEE PAGE 42

VOXNAN

PAD PRO 630 × 126 × 5+1 MM | 4-WAY BEVEL | HERRINGBONE

Voxnan floors are very durable with a high resistance to stains and wear. Vormax has a watertight surface, which makes it a great choice even for your kitchen or hallway. With the new Unizip® click system Voxnan planks can easily be clicked together, without the difficulty of trying to keep track of right and left planks. Find more information about installation on page 51.

As our Voxnan planks also come with the underlay already attached, installing your herringbone dream couldn't be easier.





WATERTIGHT SURFACE*

Thanks to AquaSafe and with a superior protective top layer which gives good resistance to stains and wear, Lysefjord brings you that look of love that lasts.

**tested according to ISO CD 4760 (no leakage).*



LYSEFJORD

Want that airy, sophisticated, exclusive look for those large areas of your home or office? Lysefjord is a series of medium planks that give any room that premium feeling.

It's available in a complete range of colours and shades to bring that understated Scandinavian elegance to your floor. The 4-way bevel truly emphasizes the size of the planks.

LYSEFJORD V4631-40107 SEASIDE OAK



LYSEFJORD V4631-40099 LIGHT DANISH OAK

LYSEFJORD

PAD PRO 1494 × 209 × 5+1 MM | 4-WAY BEVEL | MEDIUM PLANKS

Tough, medium planks that make your home or office floor look larger and more stylish. The 4-way bevel really brings out the plank size. Water resistant, high stain and wear resistance – perfect for high traffic areas. Lysefjord Pro comes with 9 unique planks per decor to give your floor that natural, wooden look.





NORDIC WHITE PINE
PAD PRO V4631-40072



WINTER PINE
PAD PRO V4631-40204



GREY WASHED OAK
PAD PRO V4631-40082



LIGHT DANISH OAK
PAD PRO V4631-40099



BEIGE CABIN OAK
PAD PRO V4631-40319



BEIGE WASHED OAK
PAD PRO V4631-40080



NATURAL DANISH OAK
PAD PRO V4631-40097



BEIGE VALLEY OAK
PAD PRO V4631-40236



PEARL BEACH OAK
PAD PRO V4631-40200



SAND BEACH OAK
PAD PRO V4631-40103



SEASIDE OAK
PAD PRO V4631-40107



GREY CLOUD PINE
PAD PRO V4631-40074



GREY VALLEY OAK
PAD PRO V4631-40237



NATURAL SWEDISH OAK
PAD PRO V4631-40316



GOLDEN CABIN OAK
PAD PRO V4631-40318



HONEY DANISH OAK
PAD PRO V4631-40098



SMOKED VALLEY OAK
PAD PRO V4631-40238



HONEY CREEK OAK
PAD PRO V4631-40088



CARAMEL VALLEY OAK
PAD PRO V4631-40315



BROWN CREEK OAK
PAD PRO V4631-40090



FUMED SWEDISH OAK
PAD PRO V4631-40317



BROWN LODGE OAK
PAD PRO V4631-40199



BLACK CITY OAK
PAD PRO V4631-40091



COLOUR MATCHING
ACCESSORIES
SEE PAGE 42



OTRA V4007-40017 MODERN GREY OAK



OTRA

Want that contemporary wood look for your floor? Otra will do just that. Featuring oak styles from soft grey to dark coffee and with 4-way bevels to accentuate that natural feel, Otra classic planks make your room look cool.

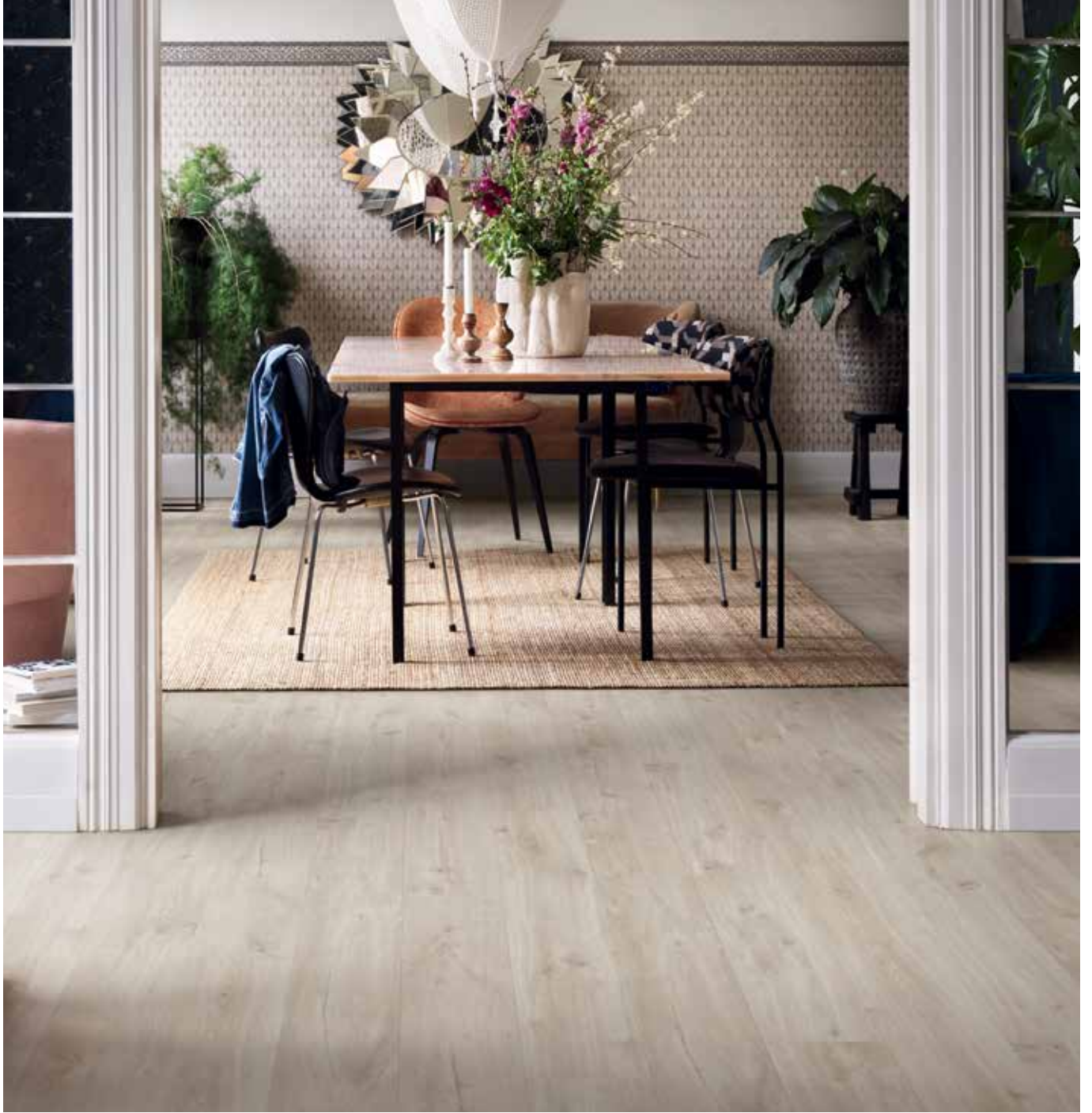

OTRA V4007-40038 BEIGE SCANDINAVIAN OAK





MODERN GREY OAK
PAD PRO V4007-40017
PRO V4107-40017



BEIGE SCANDINAVIAN OAK
PAD PRO V4007-40038
PRO V4107-40038



AUTUMN MOUNTAIN OAK
PAD PRO V4007-40322
PRO V4107-40322



SOFT GREY OAK
PAD PRO V4007-40036
PRO V4107-40036



BEIGE PREMIUM OAK
PAD PRO V4007-40277
PRO V4107-40277



SPRING MOUNTAIN OAK
PAD PRO V4007-40321
PRO V4107-40321



NATURAL SCANDINAVIAN OAK
PAD PRO V4007-40039
PRO V4107-40039



SUMMER MOUNTAIN OAK
PAD PRO V4007-40320
PRO V4107-40320



CINNAMON PREMIUM OAK
PAD PRO V4007-40278
PRO V4107-40278



CLASSIC NATURE OAK
PAD PRO V4007-40023
PRO V4107-40023



MODERN COFFEE OAK
PAD PRO V4007-40019
PRO V4107-40019



GREY HERITAGE OAK
PAD PRO V4007-40037
PRO V4107-40037



COLOUR MATCHING
ACCESSORIES
SEE PAGE 42

OTRA

PAD PRO 1251 x 189 x 4+1 MM | 4-WAY BEVEL | SMALL PLANKS
PRO 1251 x 189 x 4 MM | 4-WAY BEVEL | SMALL PLANKS

Stylish looks and soft feel, still Otra is perfect for any room where the going gets tough. Otra is coated with a superior protective layer for stain and wear resistance to keep your floor looking great. In addition AquaSafe make the floor surface watertight. Otra adds that little bit of luxury to your room.

The Uniclic® system and the pre-attached underlay of Pad Pro let you install the Otra floor quickly and easily, even on slightly uneven floors. Otra range also comes with a Pro option without the pad.





LIMFJORD

The possibilities with Limfjord are almost endless, as is the elegance it brings to any space with its modern designs, tactile surfaces and large sized tiles. Whether you are looking for playful carpet design for the children's room or a grand natural look for your hallway with a Terrazzo stone or concrete design – Limfjord is the way to go.





LIMFJORD V4622-40325 VELVET SKY

In the children's rooms, where they play and have fun, Limfjord is especially a good fit thanks to all its worry-free characteristics, such as the floor's excellent resistance to scratches and stains.



LIMJORD V4622-40334 VELVET LEAF



LIMJORD V4622-40333 VELVET ROSE





BEIGE SHELLSTONE
PAD PRO V4622-40276



GREY SHELLSTONE
PAD PRO V4622-40275



DESERT CONCRETE
PAD PRO V4622-40274



LAVA CONCRETE
PAD PRO V4622-40273

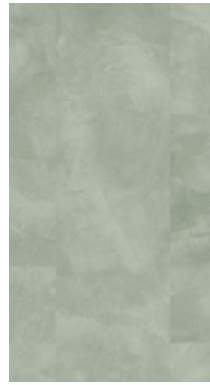

VELVET LEAF
PAD PRO V4622-40334



VELVET ROSE
PAD PRO V4622-40333



VELVET STORM
PAD PRO V4622-40326



VELVET SKY
PAD PRO V4622-40325



COLOUR MATCHING
ACCESSORIES
SEE PAGE 42

LIMFJORD

PAD PRO 856 × 428 × 5+1 MM | 4-WAY BEVEL | MEDIUM TILES

Beautiful Limfjord offers different designs for every style, and comes with a superior protective top layer that offers excellent resistance against scratches and wear, as well as stains. Thanks to our AquaSafe technology, Limfjord has a watertight surface, and is also a breeze to install due to its integrated underlay and the Uniclic® system.





AURA V4020-40234 CONCRETE STONE

AURA

From light Italian marble to black Scivaro slate, Aura offers that timeless look of stone and concrete with a soft, warm feeling while you walk. Or sit. Or play.

Aura Rigid vinyl tiles look like the real deal but are probably less fragile than your favourite type of marble. Being water resistant, extra strong, you get a true stone look that's warm and comfortable to walk on, not giving your feet that cold, hard feeling.





AURA V4020-40232 CORAL STONE



**INSTALL AURA PAD PRO
- MAKES THE JOB SUPER-QUICK**
The Aura Pad Pro range come with the underlay pre-attached,
to make installing floors smarter, speedier and easier.

AURA V4020-40136 ITALIAN MARBLE



ITALIAN MARBLE
 PAD PRO V4020-40136
 PRO V4120-40136



CORAL STONE
 PAD PRO V4020-40232
 PRO V4120-40232



CONCRETE STONE
 PAD PRO V4020-40234
 PRO V4120-40234



OXIDIZED STONE
 PAD PRO V4020-40235
 PRO V4120-40235



CINNAMON STONE
 PAD PRO V4020-40233
 PRO V4120-40233



VOLCANIC STONE
 PAD PRO V4020-40231
 PRO V4120-40231



BLACK SCIVARO SLATE
 PAD PRO V4020-40035
 PRO V4120-40035



COLOUR MATCHING
 ACCESSORIES
 SEE PAGE 42

AURA

PAD PRO 610 × 303 × 4+1 MM | 4-WAY BEVEL | TILES

PRO 610 × 303 × 4 MM | 4-WAY BEVEL | TILES

Aura is water resistant with a superior protective layer for stain and wear resistance to keep your floor looking great. With 7 different designs for every style, and 12 unique tiles per decor Aura gives any room that classic stone look. Uniclic® lets you install Aura quickly and easily, even on uneven floors.



IT ALL STARTS WITH THE FLOOR

IDEAS AND INSPIRATION FROM AN INTERIOR DESIGNER

We sat with Pella Hedeby, Swedish interior designer and stylist, to get tips on what to think about when you decorate your home. Pella has lots of experience in decorating private homes and commercial premises and is passionate about what materials you should choose and everything else about interior design, from flooring to colour combinations.



What are the main things you should think about, when decorating your home?

The bases are everything. If you have well-thought-out material choices that follow a common theme through your home, then you have a great base for the way you furnish. "Less is more" may be a bit of a tired expression, but it's so true. Put lots of thought into what you add. Often it doesn't take much to create that homely feeling. Less "things" make it easier to keep your house tidy and enjoy what you have.

What are the future trends of colours and colour combinations?

I have a restrained approach to trends. Whether it's colours, materials or things. Sure, I can be inspired by something new, but I always ask myself, "Is it something I could live with over time? Did I like this 10 years ago and will I like it after 10-20 years?"

Having said that we see more colour and playfulness in many places today. Together with a minimalist, stripped-down, toned-down expression. It's important to remember that we are all different. Some people constantly need

new impressions and a lot of pulse to get energy. I belong to the group that takes in the smallest shade, filled with a streak of light, a scent and feeling in a texture. So I need to scale back and minimize things to experience balance and harmony.

In my world, materials and textures set the tone and feeling in a room. Then you can work with the smaller details.

Tone-in-tone or mixing your favourites. Like when you put together a bouquet of flowers, layering shapes and colours.

"CHOOSE A FLOOR THAT LASTS OVER TIME"

What things about flooring should you think about if you want to give a room extra space?

Lighter shades give you a more airy feeling. It's the same when you add colour to other surfaces. It reflects light and gives you that feeling of space.

Any rules about combining colour on floors and walls?

When decorating a new home, or renovating from scratch, my tip is to always start with the floor. You lay a floor so it lasts a long time, slightly more long-lasting than the colour



of the walls. The floor forms a large part of the interior and the feeling in the room. The sense of style is set with the floor and the choice of skirtings should be in harmony with the architecture. A great way to put it all together is to create a mood board with samples of materials, colours and inspirational images.

Should flooring in different rooms have to match each other, or should I see each room as unique?

I think it's nice to think holistically and let one material be the base everywhere. But different rooms naturally have different functional requirements. So I would say that it's increasingly common to mix different types of floors based on function and focusing on sustainability.

What's the biggest mistake people make when choosing a new floor?

Many people start with colours and other materials and interior details, leaving the floor as a compromise. I suggest you turn that upside down. The main thing is to choose a floor that

lasts over time. It's costly and time consuming to replace a floor, so choose what is the base of your home carefully.

Any thoughts regarding mixing different types of wood on floors and furniture?

Instead of mixing different types of wood flooring, I'd mix and match different types of wood on floors with other furnishings. For example, it's nice to mix furniture and interior details with a vintage patina that contrast with the choice of materials. I think natural material choices are always welcome elements that add a genuine feeling to any home. If there is a "rule", it's better that it's a complete, natural contrast than something that melts together – but doesn't really. Here you can balance the feeling that if a floor takes loads of space, you can add something to balance it. Like adding a rug and then furnishing with wooden furniture. Or working with wood in smaller details, a hook strip, a wooden bowl or the frames around, art on the wall...



PELLA HEDEBY
INTERIOR DESIGNER

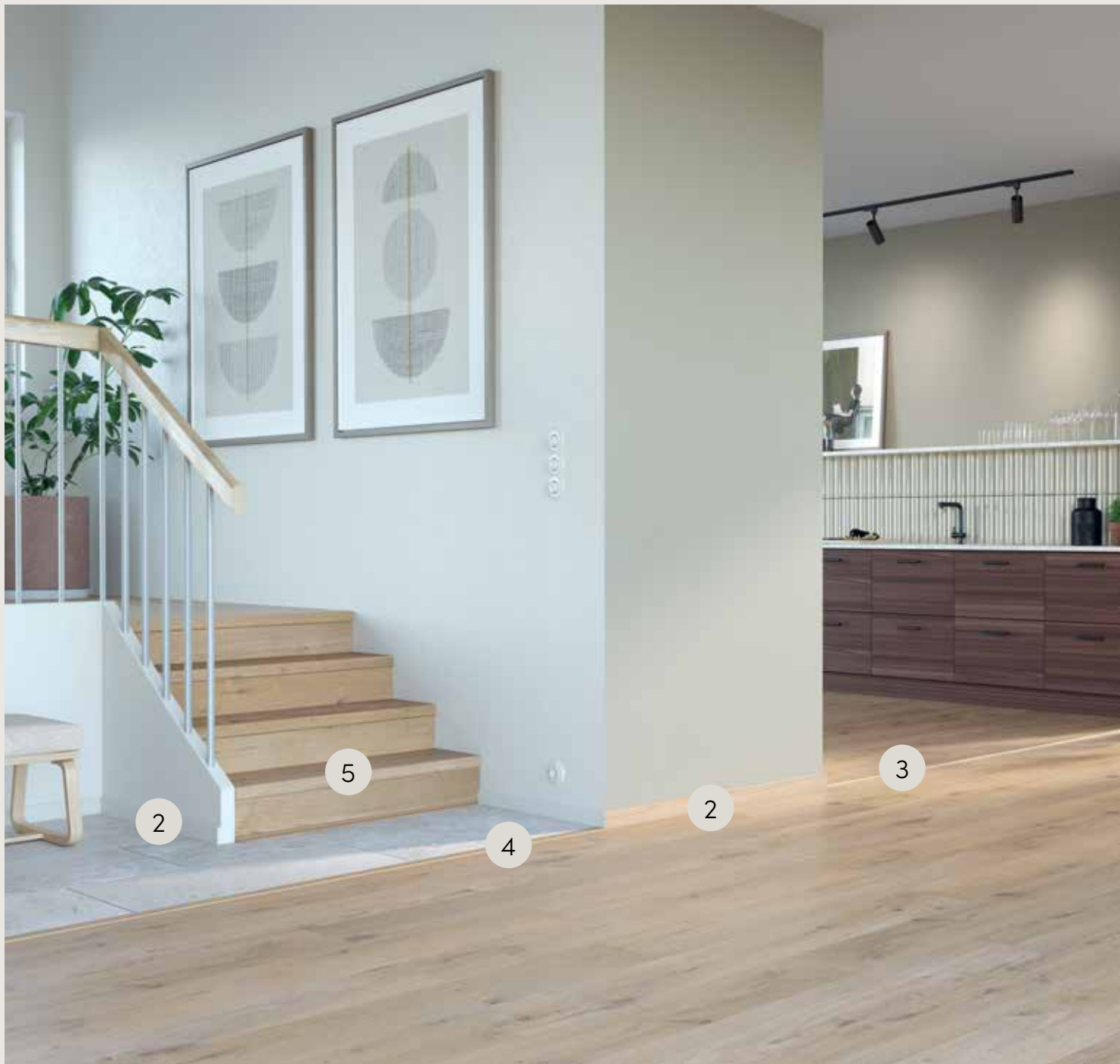

YOUR FLOOR – FINISHED IN STYLE

Choose from our wide range of accessories to give your interior that perfectly finished look. From seamless transitions to stairs or walls, silent underlays to improve your comfort or a skirting that finishes off the room in style. Details make perfection.

UNDERLAYS

Make a great floor greater. Underlays increase walking comfort, improve your room's acoustics, avoid creaking noises and support the click system. They can be combined with underfloor heating too. For our Pad Pro floors the underlay is already integrated.

SKIRTINGS

Finish the look with colour matching skirtings, or complete your interior style with one of the many paintable white skirtings.

PROFILES

Hide those saw cuts and give your floor room to expand with profiles. Create a smooth transition with the colour matched Incizo® profile. Or go for a metal finish.

ALL YOU NEED TO INSTALL, FINISH AND MAINTAIN YOUR FLOOR

A vinyl floor is more than the planks you walk on. It's a complete home decor solution. That's why Pergo also offers a full line of accessories. Everything you need for trouble-free installation, finishing and maintenance.



1. UNDERLAYS

Enjoy walking on quiet floors without creaks? Choosing the right underlay can improve your living comfort significantly. For our Pad Pro floors, underlays are not needed.



2. SKIRTINGS

Give your interior that stylish impression with skirtings that have the same look as the floor. You can also go for the white and paintable skirtings to match the colour of the wall.



3. EXPANSION PROFILES

Floors in connecting rooms melt together thanks to a colour matched expansion profile. Read on about our Incizo® 5-in-1 solution on page 44.

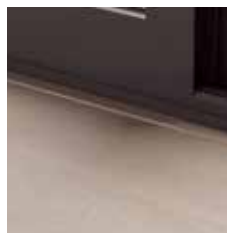

4. ADAPTER & END PROFILES

An elegant way to make a transition when vinyl floors meet other surfaces. Use an end profile between vinyl and windows and an adapter profile between vinyl and lower floor surfaces. Available in our Incizo® 5-in-1 solution.



5. STAIR COVERS

Pergo's flooring is an excellent choice for staircases. Stair covers provide an elegant finish to each step.

SKIRTINGS

When it comes to vinyl flooring, beauty really is in the details. What would the new living room floor be without the skirtings to match?



STANDARD SKIRTING
2400 × 12 × 58 mm
Colour matched with floor.
Surface: wear and scratch-resistant.
Core: HDF.

PGVSK(-)
For full article number, see colour matrix on pergo.com



PAINTABLE SCOTIA
2400 × 17 × 17 mm
Paintable, or can be left white.
Not suitable for wet areas.
Core: MDF.

PGSCOTPAINTA



PAINTABLE STANDARD SKIRTING
2400 × 12 × 58 mm
Paintable, or can be left white.
Not suitable for wet areas.
Core: MDF.

PGSKPAINTA



PAINTABLE PARQUET SKIRTING
2400 × 14 × 77 mm
Paintable, or can be left white.
Not suitable for wet areas.
Core: MDF.

PGPSKPAINTA



PAINTABLE COVER SKIRTING
2400 × 129 × 16 mm
For easy and fast renovation.
Covers existing skirting.
Paintable, or can be left white.
Core: MDF.

PGISKRCOVER



PAINTABLE WATERPROOF MEDIUM SKIRTING
2400 × 13 × 58 mm
Paintable, or can be left white.
Use the Foamstrip and Aqua Sealant to obtain a watertight finish.
Core: polystyrene.

PGHSK58PAINT

For the full article number, visit pergo.com.



* For heavy commercial use it's mandatory to use the Heat underlay in combination with Otra Pro and Aura Pro.
** Cradle to Cradle Certified® products are awarded certification based upon their performance across five critical areas of sustainability: Material health, Product Circularity, Clean Air & Climate Protection, Water & Soil Stewardship and Social Fairness.



WATER RESISTANCE MADE EASY

Installing a water resistant floor is really easy, follow the steps below and get your vinyl floors ready for splashes, damp and the kids indoor water games.

As an icing on the cake, it can bear up against a good cleaning. Only suitable for Rigid vinyl.

TWO STEPS TO GIVE YOUR FLOOR A WATERTIGHT FINISH.

1. FOAMSTRIP

15 m × 8 mm × 5 mm

An elastic filler for gaps around the floor perimeter.

NEVRFOAMSTRIP15

2. AQUA SEALANT

310 ml

Transparent silicone to combine with the Foamstrip for a watertight finish of your floor. One tube for 15 m.

PGKITTRANSP

UNDERLAYS

Select an underlay before installing your new vinyl floor. Besides creating a level floor, underlays increase walking comfort, improve your room's acoustics and avoid creaking noises. Note that a separate underlay is not needed if you choose a Pad Pro floor.



COMFORT UNDERLAY

Sustainable all-round underlay made of recycled PET flakes. Comfort Underlay is suitable for any room, has a very good all-round sound reduction and is compatible with underfloor heating or cooling. Thickness: 1,15 mm. 15 m² / roll.

PGVUDLCOMFORT 15

Walking sound reduction
Impact sound reduction



HEAT UNDERLAY*

Recommended underlay for rooms with direct sunlight (large windows) and the best choice for underfloor heating or cooling. Composed of renewable raw materials, such as plant-based oils and natural occurring fillers.** Thickness: 1,55 mm. 10 m² / roll.

PGVUDLHEAT10

Walking sound reduction
Impact sound reduction



Walking sound reduction = how much sound is reduced in the room.

Impact sound reduction = how much sound is reduced to the rooms below.

5 PERFECT FINISHES IN 1 SINGLE PRODUCT

Incizo®-patented profiles that perfectly match your vinyl floor colour.
Simply cut the profile to the shape you need.
An all-in-one solution that provides a seamless result.



FULL PROFILE TO BE CUT
2000 × 45 × 8 mm
Colour matching with floor.

PGVINCP(-)
For full article number, see colour matrix on pergo.com

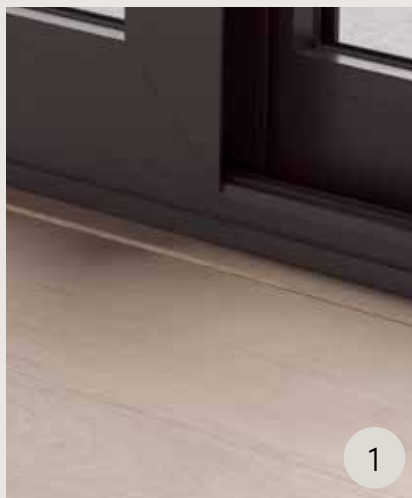

END PROFILE
2000 × 19 × 8 mm
To cover the expansion joint between floor and e.g. wall, window or threshold.

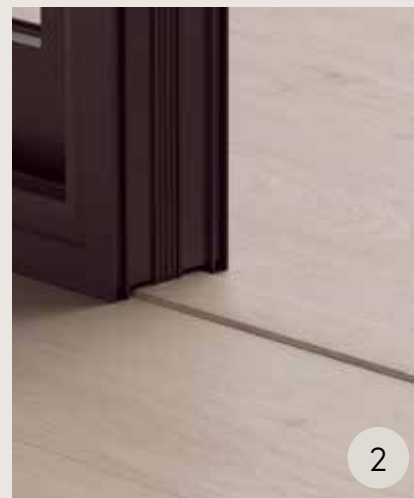

EXPANSION PROFILE
2000 × 38 × 8 mm
To cover the expansion joint between two floors of the same height.

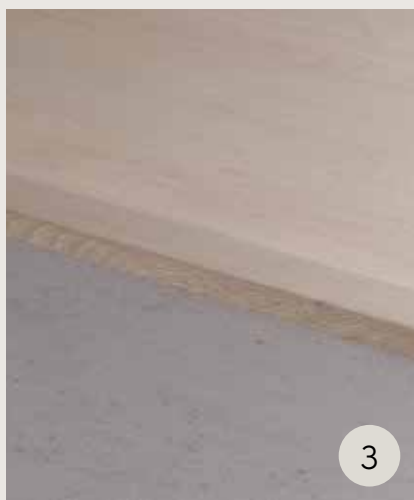

ADAPTER PROFILE
2000 × 45 × 8 mm
To cover the expansion joint between a higher and a lower floor.

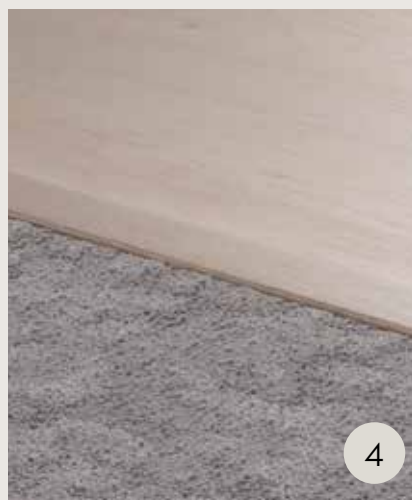

TRANSITION PROFILE
2000 × 38 × 8 mm
To cover the expansion joint between floor and e.g. carpet.



INCIZO® PROFILE FOR STAIRS
2000 × 33 × 17 mm

For the full article number, visit pergo.com.



For more information about Incizo® profile please visit pergo.com.



THE INCIZO® ALUMINIUM SUBPROFILE
Is required for stair application and has to be ordered separately.
Not compatible with Otra Pro and Aura Pro.
NEVINCPBASE1

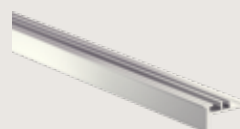

METAL PROFILES

Slim and elegant profiles in wear and scratch resistant aluminium to finish of expansion gaps.



ADAPTER PROFILE

2000 × 38 × 7 mm

To cover the expansion gap between a higher and a lower floor. Surface: aluminium.

Available in 4 colours: Silver, Coffee, Clay and Champagne.

NEVADPSILV
NEVADPCOFF
NEVADPCLAY
NEVADPCHAM

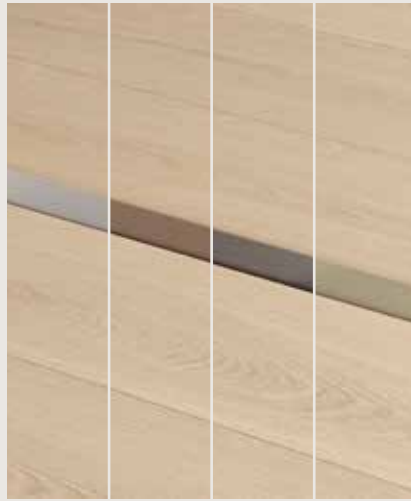

EXPANSION PROFILE

2000 × 34 × 7 mm

To cover the expansion gap between two floors of the same height. Surface: aluminium.

Available in 4 colours: Silver, Coffee, Clay and Champagne.

NEVEXPSILV
NEVEXPCOFF
NEVEXPCLAY
NEVEXPCHAM



END PROFILE

2000 × 24 × 7 mm

To cover the expansion gap between floor and e.g. wall, window or threshold. Surface: aluminium. Available in 4 colours: Silver, Coffee, Clay and Champagne.

NEVENPSILV
NEVENPCOFF
NEVENPSCLAY
NEVENPCHAM



MULTIFUNCTIONAL PROFILE SILVER

1860 × 47 × 16 mm

The Pergo multifunctional profile can level height differences for a smooth transition on to any other type of floor.

Suitable for height differences of 0 – 12,3 mm.

Surface: aluminium.

PGPRSILV

NEW MATCHED RIGID STAIR COVER

Give your staircase a fresh look with easy-to-install stair covers. These durable yet elegant stair covers are made from floor planks, which guarantees a 100% seamless matching fit with your floor. Only available for Lysefjord & Otra floors.

QUICK AND EASY INSTALLATION

A really fast way to install with Multigluue.

COLOUR MATCHED FINISH

Use the same plank as your floor to give your home that seamless look.

SCRATCH AND WEAR RESISTANT

A stair that will keep its good look years and years to come.



COLOUR MATCHED RISERS INSTALLATION

Gives your stair a seamless look from top to bottom.



PAINTED RISERS INSTALLATION

Install just the treads and paint the rest in the same colour as the wall.

VINYL STAIR COVER - BULLNOSE*

1474 x 136 x 54 mm

Durable vinyl tread cover with a bullnose stair nosing to cleanly finish your stairs. Since Stair Covers are made out of your floor's material, the colour matches 100%.

PGVSTRBMP(-) - PGVSTRBSP(-)

For full article number, see colour matrix on pergo.com



EXISTING BULLNOSE INSTALLATION

Install the staircover over the existing bullnoses.



90° STEP INSTALLATION

If the stair has no bullnose, foresee wooden bars, screws and plugs to create a bullnose.

For the full article number, visit pergo.com.



* For full description, advice the stair cover installation instructions on pergo.com. Only available for wood decors, not stone decors.

*GIVE THE FLOOR
AND STAIRS THAT
SEAMLESS LOOK*



A TOTAL FLOOR SOLUTION

Pergo vinyl flooring is well known for being easy to install. Naturally, we have all the accessories you need to do the job with ease and to keep your floor in perfect condition.

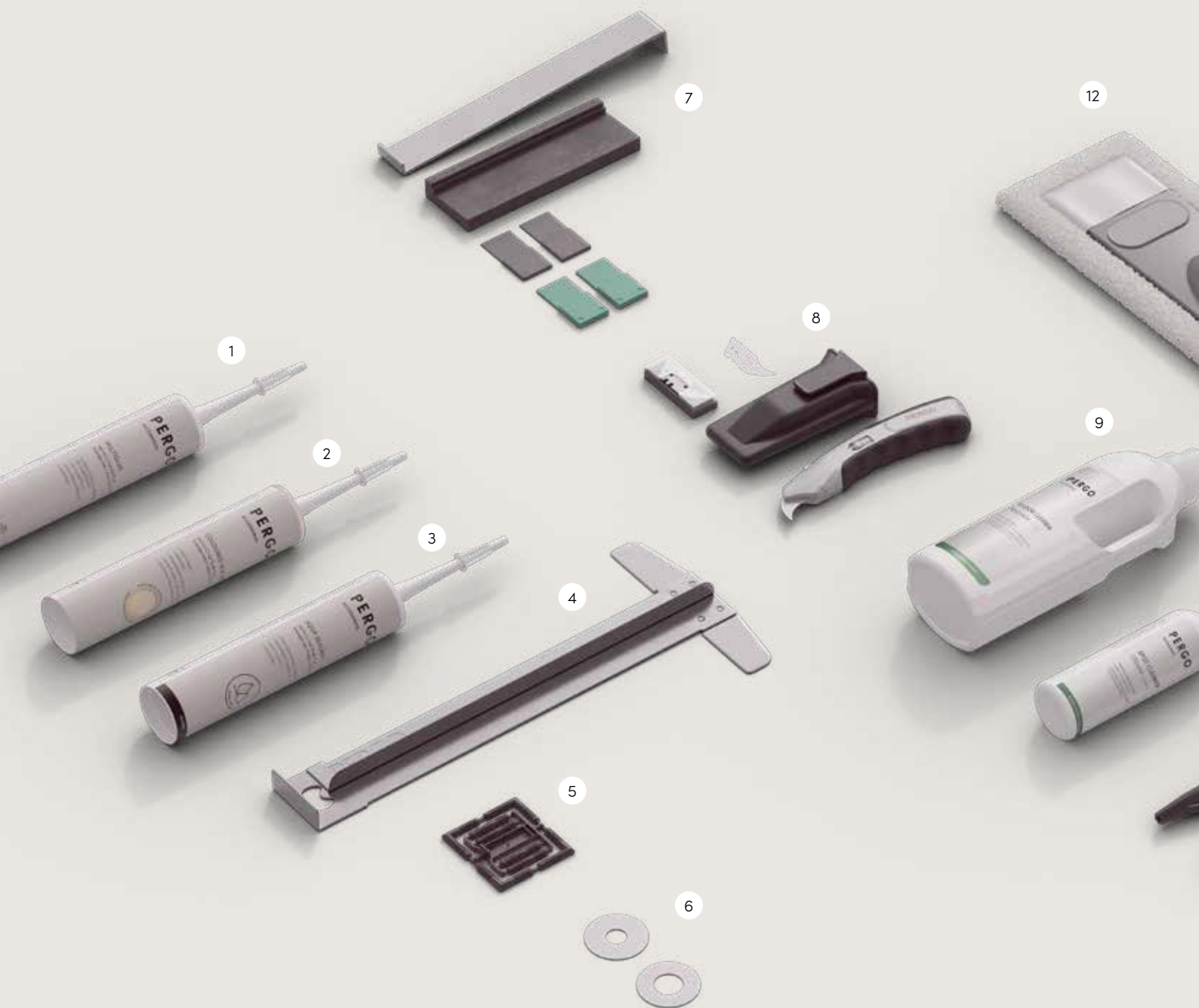

1

MULTIGLUE

290 ml

This multifunctional glue is your trusted companion while installing all Pergo accessories, whether it's skirtings or profiles - this glue is the perfect match. One tube glues 15 running metres of skirtings.

PGGLUE290

2

COLOURED SEALANT

310 ml

Acrylic-based paste for a beautiful finish between skirtings and walls. Available in 14 different colours. One tube for 15 running metres.

PGKIT(-)B

For full article number, go to pergo.com



3

AQUA SEALANT

310 ml

Transparent silicone to use on top of the Foamstrip for a watertight finish of your floor. This is necessary to take advantage of our water resistance warranty. One tube for 15 running metres.

PGKITTRANSP

4

VINYL INSTALLATION TOOL

This tool can be used in two ways: it helps you to precisely cut your vinyl floor with the Vinyl knife, while it protects your hand, and it allows you to easily install your floor in hard-to reach places thanks to the lever function.

PGVTOOL

5

PLUGS FOR SKIRTINGS

The easy way to connect skirtings, even in corners.

24 connecting plugs for inside or outside corners, 24 connecting plugs for straight stretches.

NEPLUG

6

PIPE COVERS

2 pc / pack

These stainless steel covers finish your pipes and heating elements neatly.

Inner diameter: 18 mm. Outer diameter: 54 mm.

PGPCINOX18

Inner diameter: 22 mm. Outer diameter: 54 mm.

PGPCINOX22

7

INSTALLATION SET

Installation set that contains a tapping block, a metal crowbar and spacers in two sizes (2 x 18 = 36 pcs) to quickly install your floor without damaging it.

PGTOOL

EXTRA SPACERS

48 pc

PGSPACER

8

VINYL KNIFE

Sturdy and professional utility knife ideal for cutting curves and shapes out of your vinyl floor. It contains 5 ultra-sharp and curved blades. For an optimal result, you can combine it with the Vinyl installation tool.

PGVKNIFEB

REFILL SET FOR VINYL KNIFE

This refill pack contains 40 blades for the Vinyl knife. They are packaged in a solid and safe metal box.

NEVKNIFEREFILL40

9

FLOOR CLEANER

1 l

This product thoroughly cleanses your floor, protects the surface and helps preserve its original appearance. It's biodegradable which makes it a truly sustainable choice. Floor cleaner has been specifically developed for Pergo floors.

PGCLEANECO1000

10

SPOT CLEANER

250 ml

This product removes even the most persistent stains, such as those from permanent markers, paint, red wine, kitchen spills and more. Spot cleaner has been specifically developed for Pergo floors.

PGSPOTCLEAN

11

REPAIR KIT

A quick and easy way to repair damaged planks in colours that match your Pergo floor. Contains 1 melting knife, 1 comb and 7 wax blocks. For more information on how to mix colours visit pergo.com.

PGREPAIR

12

CLEANING KIT

High-quality mop set with extra-long ergonomic handle and a mop cloth holder with practical Velcro fastener. You can wash the microfibre mop up to 60°C.

PGCLEANINGKIT



10

11

FIND THE RIGHT FLOOR FOR YOUR PROJECT

Choosing the right floor is often the hardest part of refreshing your interior. Here are some tips to get you started, and help guide you towards the perfect floor.

PREPARE FOR WEAR

Our durable, hard-wearing floors stay beautiful for longer. They are the ideal choice for a busy hallway or kitchen.

LET'S TALK ABOUT WATER

A water resistant floor is nice to have in a living room. But in the kitchen it's a must. Our water resistant floors are also stain resistant.

SIZE MATTERS

Large boards boost the feeling of space in a large room, so if your home allows for it, go big.

THE FINISHING TOUCH

Accessories have a big impact on the look of your room. Choosing a matching skirting makes your room feel complete and lends a solid impression.

USE FLOORLAB

Want more from your floor? Use the FloorLab app. Take a photo of your home and get a sneak peek of which one of our floors is the perfect match for your room. Getting the perfect fit just got simple.

VISIT A PERGO SUPPLIER

To see and feel the floors in real life, please go to our website to find your nearest local Pergo supplier.

SEE HOW A FLOOR CAN CHANGE THE APPEARANCE OF YOUR HOME JUST BY UPLOADING A PHOTO.



THE PERFECT RESULT IS JUST A CLICK AWAY

Watch step-by-step videos on pergo.com
To guide you through the whole installation process

UNICLIC®: FAST AND EASY CLICK INSTALLATION

The smart Uniclic click system offers two different installation options and will make your job quick and easy.

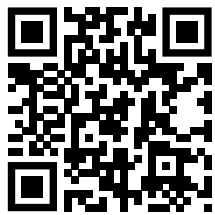

NEW UNIZIP®: HASSLE-FREE HERRINGBONE INSTALLATIONS

While most herringbone floors require two types of panels (left and right), the Unizip® technology makes it possible to lay the floor with one type of panel only.

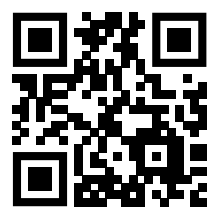



PERGO®

Floors for real life

a brand of  UNILIN

Product images may differ from actual product. The availability of products, or the products themselves, may change at any time without notice. With reservation for errors. Contents © 2023 by Unilin bv – division flooring. All Rights Reserved. The contents of this brochure may not be reproduced in whole or in part without prior written permission from the publisher. For consumer questions and retailers visit pergo.com.

Pergo is a quality product produced by UNILIN BV, division flooring, Ooigemstraat 3, 8710 Wielsbeke, Belgium